

# T'AU KOR'OR'VESH – THE ARMADA

## EVOLUTION OF THE TAU BATTLEFLEET

As the nascent Tau began to stretch their hand across the stars and assume the manifest destiny they saw within themselves to colonize the greater galaxy, it was only a relatively short time before they began to encounter other spacefaring races. Because their own interstellar drive systems were derived in part from alien technology discovered on one of the moons in their home system, they were from the outset very open-minded to this possibility and were quick to form trade agreements and colonization pacts with all they encountered. The first of these was the natural deep-space explorers that are the Nicassar. The Tau's technology proved to be vastly superior between the two, and the inevitable conflict arising from misunderstanding proved to be relatively short. Extremely poor warriors and completely unsuitable for a military role in the Greater Good, the Nicassar lent their natural skill in space to building vessels for the Empire, and their innate curiosity and desire to explore the galaxy made them uniquely suitable as scouts, slowly and methodically plying the depths of space between the stars.

Heady with this success, the Tau earnestly believed that no race they encountered could turn from the unsullied logic of "greater good" as well as the superior technology they had at their disposal. When they once again encountered another spacefaring race, they quickly rushed to establish contact. Their naïve suppositions were cruelly shattered. What they encountered were Ork raiders, brutal killers bent only on war and conquest. Referred to as the

"Ours is to be an empire of worlds, not merely of castes or nations, or races or peoples. To simply control the worlds which we claim as our own will not be enough – we must control the paths between them also, or be divided, and so fail."

– The Air Caste Petition  
ahead of the Tau'n Campaign

O'res'la, it took little time before first contact with the Orks turned to open war. While this vanguard was rebuffed after much struggle, it proved in the intervening centau'cyr to only be a foretaste of the woe that was to come. At first the Tau took it to be a war of ideologies, as the O'res'la expansion directly interfered with the Tau's plans at colonizing and expansion of their sphere of influence. It was not long before the realization set in that this was indeed a battle for survival, as the O'res'la with their technologically superior vessels quickly cut lines of communication between worlds and threatened to come within range of the Phase One Septs themselves. In the midst of this, the Tau continued to expand their sphere of influence in the systems surrounding their homeworld in their race to explore and colonize the stars. They rightly ascertained this was not only paramount to their manifest destiny, but quite possibly could prove to be the key to their very survival.

This ethos proved itself during an otherwise unassuming merchant expedition to newly discovered Pech, the homeworld of the Kroot. A lasting alliance was forged in the fires of battle as the visiting delegation and its cadre of Fire Warriors stood beside the local defenders against an invading O'res'la war-host. During this battle, the Kroot proved themselves to be quite able defenders as well as frightfully brutal and efficient close-quarter fighters. The Ethereals, recognizing an unparalleled opportunity to gain an ally as well as a new source of information vital for their cause, quickly interceded to negotiate a lasting peace and alliance between the two races. The Kroot took advantage of an opportunity to expand their access to technology and resources, willingly allowing themselves to become subjects in a sense and forming an alliance that quickly became a cornerstone of the emerging Tau Empire. In return, they lent their expertise in hand-to-hand fighting and natural warrior skill to benefit the Tau, using this opportunity to expand their

travels and pursue the hunt, constantly shaping and improving their genetic bloodline by sampling the gene pools of alien creatures and races they encounter.

As they continued to expand, the Tau encountered the Demiurg, another spacefaring race with which the Kroot had long experience as hired mercenaries. Plying the stellar void in ponderous, stately factory ships and powerfully armed commerce vessels, this ancient race saw an unusually strong kinship between themselves and the Tau. Referred to by the Tau as the Bentus'la (Lit: *wise-gifted ones*), they declined an invitation to join their Empire. They did however realize that together they could be potent allies against continuing predations against the Orks, as the Demiurg's history with them in particular was an exceedingly long one brimming with hatred, loathing and bitterness. In particular, Brotherhoods referring to themselves as Thrum and SrryTok in their unusual, clicking, consonant-heavy language formed strong economic partnerships with the Tau.

Technological advancements gained through this relationship completely revolutionized Tau weapon development as well as the very structure of the Shas (Fire) caste and its role in the Tau's interstellar exploration. Now the Tau were capable of building vessels that could fight the Orks on equal terms, and they wasted no time applying these technologies to new starship designs. Both Gal'Leath explorers and the ubiquitous Il'fannor heavy transport maintained the ability to tow with them large cargo lighters capable of quickly transporting large quantities of materiel between orbit and a planetary surface. However, it was found that by replacing the cargo capacity of these lighters with modularly mounted ion cannons, they could quickly be transformed into extremely capable escort gunships in their own right. This new escort design, dubbed the Kess'l, proved to be so successful at defending their charges that ion cannons were applied to Il'fannor vessels

themselves, a measure that met with only limited success. Because the Tau found this arrangement to be less than satisfactory, they did not attempt to place these weapons on their Gal'Leath vessels, though the Bor'kan Sept produced a variant of the Gal'Leath that substituted launch bays with a powerful gravitic launcher system capable of putting a veritable storm of drone-linked missiles into space.

These advances came just in time. Sporadic attacks on Tau shipping and communication lines erupted into the inexorable tide of Waagh! Scraghurtz, a vast Ork armada sweeping through that part of the galaxy, already responsible for overrunning dozens of worlds. Despite the Tau's technological advances, it was likely that they would not have prevailed against the amassed might of Waagh! Scraghurtz. Unknown to the Tau however, the Demiurg cultivated relations with races even far more ancient than themselves, and in less than a kai'rotaa the grim pressure this mighty Ork-mada applied to the fledgling race vanished as suddenly as it came.

In the route of its expansion, it was inevitable that the Tau would eventually encounter the unimaginably vast domain that encompassed the Imperium of Man. The well-documented Damocles Gulf Crusade and their war with whom they called the Gue'la was the nearly inevitable result. As fortune would have it, the Tau already had established relations and trade agreements with a number of Rogue Traders. This served them well, as they to an extent has a measure of preparedness for what to expect. The human invasion fleet was nonetheless brutally efficient, and the Tau suffered mightily in this war. The outcome at Hydrass in particular was widely considered to be a disaster by the Tau. Lessons learned were rapidly applied however, and they developed their first true interstellar warships in the form of the Kir'Qath escort as analogues to those they faced, serving alongside exploration carracks and heavy transports refitted as combat vessels using up-rated weapon and defensive systems. Though constructing dedicated warships was against the philosophy of a culture that



strived to solve every challenge with diplomacy, trade, ingenuity and not a little cunning, it was recognized that it was necessary against such an intractable foe as the Orks. Despite this, warships were initially produced very sparingly, as many of the Ethereal Caste believed that the bulk of the Kor'vattra's resources needed to focus on its primary goal: commerce and exploration to unite the stars in support of the Greater Good. Once again the fickle hand of fate played in favor of the Tau, and the Gue'la were forced to commit to a cessation of hostilities, beset on multiple fronts by a burgeoning assault by what they called Hive Fleet Behemoth as well as continuing raids by the O'res'la.

The lessons of the Lithesh War were not lost on the Tau, and within twenty tau'cyr of the Armistice, the

Lar'shi cruiser took to space, the Tau's first purpose-built warship and the vessel with which they would re-take the stars. Parallel to this, various capital ship and escort variant designs were experimented with. While the Lar'shi was a formidable warship in its own right, it was still based on the modular transport concept the Tau relied on for generations, a concept favored by the Kor caste that was simple to construct and maintain but suffered the same efficiency and interstellar warp dive shortcomings as other Tau vessels. Nonetheless, these warships proved their worth, and they increasingly became available throughout the Tau fleet. As Tau technology evolved to match that of the Gue'la, it began to easily surpass that of the Orks, and a modernized fleet defending the D'yanoi system handily defeated a comparable fleet of Ork vessels.

In the midst of these advances, a whole new foe revealed itself in what the Gue'la called the Tyranids. Outriders of which were first encountered in the outlying worlds near the Fal'shia Sept, they proved to be an intractable foe, unable to reason, devouring all before them in an insatiable tide of annihilation that consumed worlds as surely as fire does dry brush. Once again the Kor'vattra's performance and tactics against a new enemy were called into question. The problem wasn't yet a crisis, but the Ethereals and Air Caste saw its potential to rapidly develop into one should this new foe prove to be as widespread or problematic as the Gue'la. To



this end, the Ethereals, Air Caste and Earth Caste urgently re-thought their policies for the future development of the Kor'vattra. The Tau finally realized that the status quo was no longer adequate. They would have to bend the full ability, resources and technological prowess at the Empire's disposal to the task of creating a completely new range of vessels designed from the outset as warships with a level of redundancy, efficiency and dive range that were beyond the limits of current starship construction techniques. The faith the Tau have in their Fio caste and its grasp of technology is unshakable, and once again they did not fail to deliver.

Engineers and artificers long familiar with the needs and requirements of the Shas caste were invited into the design process. No effort was to be spared. The project as a whole was soon referred to as the Kor'or'vesh, and it incorporated the single largest re-allocation of resources in the history of the Tau Empire. The result was a new, 'experimental' fleet, a number of radically different starship concepts that bore strong resemblance to the Tau machines of war rather than the modular hulls and platforms familiar to the Kor. For the first time, purpose-built warships were designed to fully integrate the Fire Warrior command structure into the crew, and they represented the very apex of technological

advancement of the Tau race. However, these vessels proved to be especially difficult and expensive to produce, and extensive assistance was required by both the Nicassar and the Demiurg to bring them to fruition. The first vessel created by the new initiative was the Il'Porru, and it proved to be a revolutionary advance indeed. Able to make interstellar dives nearly five times farther than conventional designs, this vessel was promptly taken up by the Por caste as a means to rapidly traverse the breadth of the Empire as well as quickly and efficiently explore beyond their realm. In their first contact, a pair of these vessels quickly bested a small pack of Or'es'la raiders encountered near D'yanoi, proving the concept was sound- and so the Kor'or'vesh, the Tau Battlefleet, came into its own.

The threat represented by the Gue'la subsided but was not removed. Once again they attempted to press their will against the Tau during the Taros Campaign. Fortunately by this time the Tau had finally fielded significant numbers of their new warships, and a number of Septs deployed these vessels in significant numbers only a few tau'cyr before they would be tested in the fires of battle against an Imperial fleet. Quickly called to the front from throughout the Empire, these vessels became the core of a newly created fleet command to meet the invasion fleet head-on. The first of these new

... it has been concluded that, after careful analysis of data gathered during the Damocles Gulf crusade, that this new race identified as the Tau (ref AdMech 5432/XEN583) poses a threat to the Imperium unlike any other yet encountered. Interrogation of prisoners known to have colluded with these xenos describe them in various different ways, but the same basic trends appear pointing to a common theme, describing this race in glowing expressions like "dynamic," "open-minded," "compassionate," and other terms expressing ideals that are markedly out of keeping with willful obedience, service and discipline, as well as representing a direct threat to order that has maintained our blessed Imperium for uncounted centuries. Furthermore, their evolutionary traits represent a rate of development orders of magnitude more accelerated than any sentient life form previously encountered (possible Chaos influence?), at a level that cannot even be explained by Zachary's Theorem of Adaptive Divergence (ref AdMech 32/XEN583). Evidence exists that even as contact with Imperial units increase, the level of development evident in the vessels they array against us continues to increase in complexity and technological development. In particular, xenos vessels encountered during the Taros Campaign show extremely marked advances in both weaponry and design theory compared to those encountered during the Damocles Crusade (ref AdMech 8748821/XEN583, notes on new classes "Emissary," "Warden," etc.) Recommend directive be made to all Imperial units that great care should be taken to prevent our blessed technology from falling into the hands of these aliens, especially our venerable starships and weapons of the Legio Titanicus. If necessary, steps should be taken to destroy what cannot be recovered, with a level of prejudice exceeding even that reserved against the foul Orks. Emperor forbid what circumstance may come to pass should these aliens ever develop the ability to construct a Titan, or warships that approach a level of capability comparable to ours...

-Morris Montesigna, Genetor Secundus

ships to be encountered by the Imperial fleet was the Il'Porru during fighting in the Dolumar system. Codifying it as the 'Emissary' class, the single vessel was eventually destroyed, but the new class of ship was noted with surprise and concern amongst many commanders and tacticians, more than one assuming erroneously that the Tau had established an alliance with a hitherto unknown, highly advanced alien race.

The Tau took advantage of their new capabilities to stretch the hand of their Por-caste diplomats far and wide, encountering a number of new, minor Xenos races such as the Vespids and inviting them to join their empire as part of the Greater Good. It was not long afterward that new, larger variants of Kor'or'vesh ship designs were encountered in increasingly larger numbers by the Imperial Navy as the Taros Campaign progressed, the Tau using this conflict as a testing ground. Up to this time they had been nothing more than anomalies, encountered only occasionally as the Imperial fleet progressed into Tau space. The arrival of these new ships in substantial numbers took Fleet Admiral Kotto by surprise. Given the Tau fleet's performance, their numbers may increase as the Kor'vattra of other Septs seek to adopt the new classes, integrating them into their fleet structure as these ships redefine the Kor's role in defending and advancing the Greater Good.

These dedicated warships are far too precious to be used merely as convoy escorts or deep-space patrol vessels, as these roles are already suitably engaged by other starship designs. However, the Tau depends on the Kor'or'vesh to defend their vital Phase One Septs, and will also unhesitatingly deploy them in force to support a particularly vital commerce and exploration fleet. They are also called upon to perform punitive expeditions against pirate raiders or as an invasion fleet for a hotly contested system. Finally, a race so keenly attuned to the importance of commerce and exploration is quick to grasp the impact of interrupting the lines of communication and provisions of an enemy. It is not uncommon to see these ships used as commerce raiders, as the older designs were used on occasion for many hundreds of tau'cyr.

### DOSSIER: Kor'O Vash'ya Y'eldi Mesme - 110 points

At 41 Tau'cyr, O'mesme is of a great age for his kind, but this has done nothing to dim the fire in his eyes or the great skill and subtlety with which he wields the ships under his command. Hailing from a world renowned for the history and tradition of its Kor caste, he began his career as a pilot for one of the fighter squadrons of the Kor'vattra. Quickly advancing to the level of squadron commander and soon that of an entire Gal'Leath attack craft wing, he earned the title of Y'eldi, or "winged one," for his particularly gifted skills as a pilot in their unceasing conflicts against the Orks. Moreover, his tactical genius did not go unnoticed, and it was only a matter of time before he was selected to command a starship, first as command pilot of a Kass'l gunship, then later of the first ship to carry his name, the T'olku Il'fannor M'poth Vash'eldi.

It was at this time that he was given the name Mesme, when assigned as a flotilla leader of two other Il'fannor vessels by his Kor'O as part of a colonization fleet near Tash'var. During a surprise attack by Ork pirates, he daringly interposed his vessel between an attacking Onslaught squadron and another Il'fannor vessel crippled by an earlier firing pass. During this engagement, he continuously stayed one step ahead of their adversary, constantly interposing his best ships between the attacking enemy and the flotilla. As their railguns continued to hammer out at the Orks, they stubbornly refused to retreat, and in a relatively short engagement the entire enemy squadron was destroyed. Soon afterward he was given command of a Gal'leath exploration vessel, where his exploits against the Orks soon became the stuff of legend. His vessel was at the Dal'yth system when word of the attack against Viss'el by the Gue'la reached them, and he once again performed admirably against these invaders.

Kor'O'Mesme is embarked aboard the Kor'or'vesh vessel *Bor'kan Or'es El'Leath Se'arle O'Mesme*, is Leadership 9 and has two re-rolls. Aun'Shear, a revered member of the Ethereal Caste and a close personal friend, always accompanies him. His love of flight has never diminished, and he continues to fly a fighter out of his own hangar bays, true to his name Y'eldi. This inspires his pilots to drill even harder and accomplish feats of bravery that has made his attack craft wings legendary in the annals of the Tau. The attack craft squadrons of his flagship have the Excellent Pilots crew skill. As a revered fleet commander, his vessel takes advantage of the very best technology the Fio Caste can produce for the Greater Good. His ship can be refitted with Improved Logic Engines enabling his vessel to avoid leadership effects for being in contact with blast markers for +10 points instead of the normal +10% cost.



# TAU SPECIAL RULES

## TAU WEAPONS

### Turrets

Tau turrets are extremely sophisticated, combining a range of weapon types with overlapping fire zones. Note the Tracking Systems special rules. *See p. 29 of the main rulebook for more on turrets.*

### Ion Cannons

Ion cannon shots vaporize the object struck magnifying the energy discharge. They function as lances in all respects.

### Railgun Batteries

Railguns of the size mounted on warships require massive amounts of energy to fire. Power is routed to a single barrel at a time, sequenced to ensure the first barrel is reloaded before it is charged again. Railguns function as standard weapons batteries.

### Gravitic Launcher and Tau Missiles

Gravitic launchers are massive railguns where mass drivers trigger the initial acceleration before the ship's gravitic field is pulsed to squeeze the drone-controlled missiles toward the enemy at enormous speed. Though smaller and more numerous than torpedoes in the regular sense, they count as torpedoes for the strength listed in a given ship's profile. Tau torpedoes are able to alter both speed and trajectory, moving between 20cm to 40cm each ordnance phase. They are guided and may turn up to 45 degrees at the start of their movement. Roll a D6 for each torpedo strength in the salvo at the start of each ordnance phase after the one they were launched, removing one for every 6 rolled.

### Attack Craft

#### **Special Rules of the Tau Kor'or'vesh:**

*Kor'or'vesh vessels incorporate the very highest level of technology available to the Tau. They have a distinctly different appearance to ships of the Kor'vattra. However, except where noted, these vessels follow all standard rules for Tau vessels as presented in Armada.*

*Kor'or'vesh capital ships embark a number of Fire Warrior cadres specially trained in shipboard combat and boarding techniques as an integral part of the crew. These vessels ignore the rule for Tau ships halving their boarding strength for the size of the ship. However, even these vessels do not have the ability to conduct teleport Hit and Run attacks, as the Tau have not yet mastered this technology to an acceptable degree.*

Barracuda superiority fighters behave as fighters in all respects but due to their inferior technology only move 25cm per ordnance phase. Manta Missile Destroyers are enormous and well-defended individual vessels more akin to proper starships than attack craft. When intercepted by fighters, they roll a D6 once per ordnance phase, remaining in play on a roll of 4+. They otherwise ignore any other type of ordnance the same way other bombers do.

### Gravitic Hooks

Gravitic Hooks are large, suspensory arms which create a gravitic sheath in which a small vessel can be transported by a larger one. However, gravitic hooks have no effect in game terms – ships do not start a game attached to their parent ship, and can never be docked during a game. Likewise, the number of gravitic hooks is unimportant when calculating victory points, in that an opponent does not get VPs for surviving escorts just because there aren't enough Gravitic hooks to notionally transport them to safety.

## TAU SYSTEMS

### Deflector

The deflector is a specialized shield mounted on the prow of the latest Tau ships. It turns the gravitic sheath around the vessel into a wedge, increasing its defensive capability. If fired at from the front, the deflector augments the passive armor and counts as armor 6. Deflectors are always mounted on the prow and will be disabled if the ship suffers a prow weapons damaged critical (repaired normally). Deflectors are NOT shields and do not count as such for the purpose of boarding, blast markers or other

effects which apply to shields.

### Tracking Systems

Some Tau starships and orbital platforms boast highly advanced data storage and processing facilities to cope with the vast amounts of information they carry. When linked to ship sensors, this processing power can be used to provide a direct feed to the ships turrets. In fleet actions this system can route data to nearby Tau vessels. Any Tau vessel within 10cm of a ship with tracking systems may re-roll misses when using turrets, and ignores the column shift when firing batteries at ranges above 30cm. Tracking systems continue to function even if a ship is braced for impact.

## USING TAU STARSHIPS

Unless noted otherwise, Tau vessels follow all the normal rules from the Battlefleet Gothic rulebooks concerning leadership, movement, shooting, critical damage, etc. Tau have an attack rating of 2.

### Boarding Actions and Teleport Attacks

All Tau vessels except Kor'or'vesh warships have a boarding strength that is half normal for the size of ship. Kor'or'vesh warships have a standard boarding value. Tau ships may not conduct teleport hit and run attacks.

### Campaigns

Tau fleets gain renown and leadership in the same manner as Imperials and may use the refits and crew skills tables on p.156-157 in the Battlefleet Gothic rulebook. They do not have access to the special refit tables listed on p.156-157 of Armada, though they may use the special ordnance rules listed on p.158.



# OR'ES EL'LEATH "CUSTODIAN" CLASS BATTLESHIP ..... 330 Points



Experience with the Gal'Leath in combat, particularly against the Gue'la incursion into sovereign Tau space during the Damocles Crusade, demonstrated a number of significant shortcomings that could not be overcome without a radical hull redesign, despite notable advances incorporated into the experimental Bor'kan variant of the venerable Gal'Leath. As the Kor'or'vesh initiative bore fruit with a progressively larger series of completely new and successful hull designs, it was only logical that the next step would be to produce a true battleship-class vessel.

An enormous carrier, it is capable of bringing three gunships as well as a large number of attack craft squadrons into combat to support the rest of the fleet. Early operational tests proved that like the other designs resulting from the Kor'or'vesh initiative, it met or exceeded all objectives required for the new ship. Despite the horrendous costs and resource expenditure involved in building these vessels, a number of Septs adopted the design and produced them in small numbers. For many tau'cyr these ships were held in reserve, and it was quite some time before knowledge of this vessel's existence became widespread.

First encountered by Imperial forces led by Admiral Kotto during the Taros Campaign, the "Custodian" class and its attendant escorts were a complete surprise to the Imperial fleet. Appreciating the threat this class represented, the battleship *A'rho* in particular was ruthlessly hunted down and destroyed by Admiral Kotto's fleet.

TYPE /HITS	SPEED	TURNS	SHIELDS	ARMOR	TURRETS
Battleship/10	20cm	45°	3	5+	4
ARMAMENT		RANGE	FIREPOWER/STRENGTH		FIRE ARC
Port Railgun Battery		45cm	6		Left/ Front
Starboard Railgun Battery		45cm	6		Right/ Front
Port Ion Cannon		45cm	1		Left/ Front
Starboard Ion Cannon		45cm	1		Right/ Front
Stern Gravitic Hook		-	Capacity: 3 Wardens		-
Port Launch Bays		Mantas: 20cm Barracudas: 25cm	3		N/A
Starboard Launch Bays		Mantas: 20cm Barracudas: 25cm	3		N/A
Prow Gravitic Launcher		Speed: 20-40cm	8		Front

**Notes:** The gravitic hooks of Custodian battleships are enclosed in a single shrouded, hangar-type enclosure specifically designed for Kir'la "Warden" gunships and are unsuitable for the transport of or to count for other escort types. Custodian battleships cannot undergo Come To New Heading special orders.

Custodian battleships are equipped with a deflector that raises its prow armor to 6. This is disabled whenever the vessel suffers a prow critical hit (repairable normally).

The Custodian has an integrated Tracking System coupled to an extremely sophisticated sensor suite. It functions in the same manner as that on Messenger starships in all respects but has a range of 20cm.



# KIR'LA "WARDEN" CLASS GUNSHIP ..... 30 Points

"Warden" shown in attendance with "Custodian" battleship

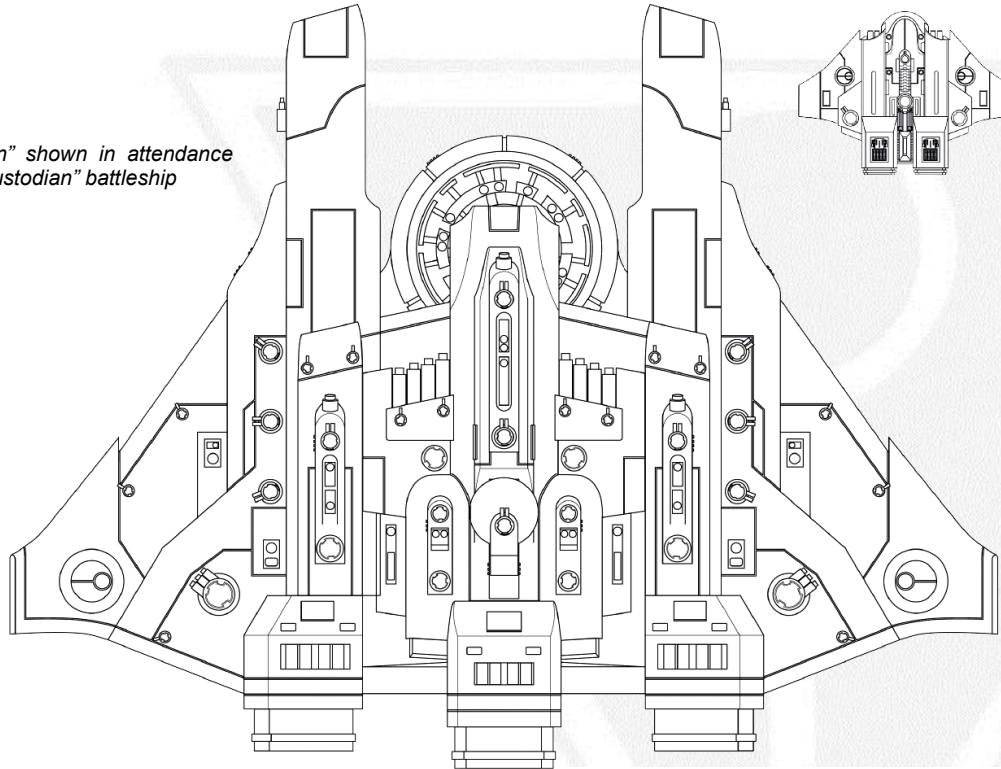

The Kir'la "Warden" is a radical departure in gunship design for the Kor'vattra in that while it still requires towing via gravitic sheath by larger vessels, it is designed for and crewed primarily as a combat vessel as opposed to being a re-configured cargo lighter as is the Kess'l. Because of this, it can seamlessly integrate itself into Kor'or'vesh flotillas, though it will still operate independently as an escort squadron when assigned to escort Gal'Leath or Il'fannor vessels of the Kor'vattra. Because of the high experience levels of its crews and its superior maneuvering qualities when compared to the K'essl, it has proven to be a formidable adversary to attacking raiders. However, its numbers will not be sufficient to replace the Kess'l in active service for quite some time because of its complexity, and only rarely is it used in this manner.

Despite technological advances in etherdrive technology, the Kir'la's small size makes it extremely difficult to put an efficient interstellar drive system into its hull. Thus it must always be towed into combat and launched after its mother ship enters a system. The Or'es El'leath is specially designed to quickly deploy these vessels immediately upon entering combat, and it operates with the Kir'la exclusively as its towed gunship escort. While Wardens have been on occasion used in other roles, it was designed primarily to protect their vitally important carrier battleships and will rarely be seen too far from their side.

TYPE /HITS	SPEED	TURNS	SHIELDS	ARMOR	TURRETS
Escort/1	25cm	90°	1	5+	1
ARMAMENT		RANGE	FIREPOWER/STRENGTH		FIRE ARC
Prow Railgun Battery		30cm	2		Front
Prow Ion Cannon		30cm	1		Left/ Front/ Right

*Notes: Any Tau fleet may bring Wardens to battle on gravitic hooks instead of Orcas. Any ship equipped with Wardens can only be equipped with Wardens and may not have other hook-transported escorts. These then form an independent squadron in all respects (including separate leadership), as they are Kor'or'vesh vessels and not necessarily related to the parent vessel transporting them. They may squadron with Castellan escorts in the fleet if present (max. six per squadron) but not with any other escort types.*

... You should go back to your Emperor and tell him what you have seen here. Tell him of all the people that will die in his name, and ask him if it is worth such-a price to stand in our way.

- Aun'O T'olkū K'yina



# LAR'SHI'VRE "PROTECTOR" CLASS CRUISER ..... 185 Points

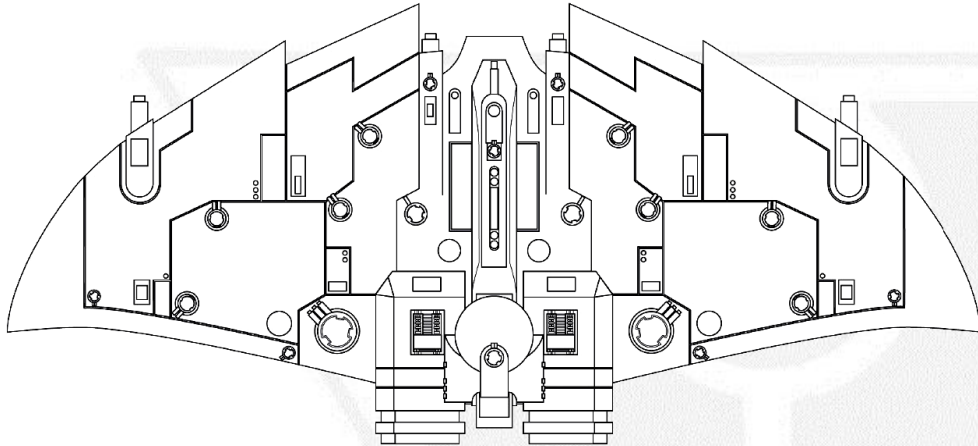

LAR'SHI'VRE T'OLKU CONFIGURATION

TYPE /HITS	SPEED	TURNS	SHIELDS	ARMOR	TURRETS
Cruiser/6	20cm	90°	2	5+	3
ARMAMENT		RANGE	FIREPOWER/STRENGTH	FIRE ARC	
Port Railgun Battery		45cm	2	Left/ Front	
Starboard Railgun Battery		45cm	2	Right/ Front	
Prow Railgun Battery		45cm	6	Front	
Port Ion Cannon		30cm	1	Left/Front	
Starboard Ion Cannon		30cm	1	Right/Front	
Prow Launch Bays		Mantas: 20cm Barracudas: 25cm	1	N/A	
Prow Gravitic Launcher		Speed: 20-40cm	5	Front	

*Notes: All Protector class cruisers are equipped with a deflector that raises its prow armor to 6. This is disabled whenever the vessel suffers a prow critical hit (repairable normally). Long-range ion cannons are a recent development; T'olku configuration Protectors must outnumber those of the Vior'la configuration in a Tau fleet.*

Based on the mission envisioned for the Lar'shi'vere cruiser, the Lar'shi'vere "Protector" cruiser is the primary combat vessel of the Kor'or'vesh, the first starship designed by the Tau specifically to engage and destroy enemy vessels in fleet actions. Like many other Kor'or'vesh vessels, this class was first encountered during the Taros campaign. While it does not have the same bulk and durability as comparable Imperial vessels, it is the first Tau design capable of meeting Imperial cruisers on nearly equal terms. Two Lar'shi'vere vessels formed the fighting core of the Tau fleet defending Taros, and it inflicted heavy losses on the invading fleet's transport ships.

In subsequent decades, this vessel has been encountered in ever-increasing frequency, not only in defense of Tau home worlds but abroad outside of Tau-controlled space, operating in pairs while accompanying colonization fleets or as deep space patrols reminiscent of the operations common to the Imperial Navy. They have wasted little time capitalizing on the Imperium's heavy commitments in the sectors near the Eye of Terror, and this class has played a pivotal role in the Tau's recent explosive advance into Imperial space.

Kor'uil Vash'ya Tozhan lowered himself into his blast couch and glanced at the control surface to trigger the emergency restraints. He never locked himself down until the last moment before combat, he was air-caste born and orbital-raised, swimming in zero gravity was far more natural to him than walking. His vessel had accelerated to optimum speed and was rapidly closing with his human quarry. Tozhan confirmed that the intercept point had appeared on his tactical display and a countdown to intercept had started. All his railgun tubes were loaded and the huge energy charge needed to fire them could be released on his command. This was one consignment of Gue'la supplies that would never reach the fighting on Arthas Moloch...



## LAR'SHI'VRE VIOR'LA CONFIGURATION

TYPE /HITS	SPEED	TURNS	SHIELDS	ARMOR	TURRETS
Cruiser/6	20cm	90°	2	5+	3
ARMAMENT	RANGE	FIREPOWER/STRENGTH		FIRE ARC	
Port Railgun Battery	45cm	2		Left/ Front	
Starboard Railgun Battery	45cm	2		Right/ Front	
Prow Railgun Battery	45cm	4		Front	
Port Ion Cannon	45cm	1		Front	
Starboard Ion Cannon	45cm	1		Front	
Prow Launch Bays	Mantas: 20cm Barracudas: 25cm	1		N/A	
Prow Gravitic Launcher	Speed: 20-40cm	5		Front	

As I scry far across the skein of time to where the mists of the distant future cloud any certainty, the one revelation that over and again asserts itself is the eventuality of conflict between our two races. However, the journey toward that distant end is one replete with the gossamer caress of hope and promise, a faint glimmer in an otherwise frigidly dark and unforgiving universe the likes of which has not been glimpsed since the Fall...

- Glébrwyn Tithrandil,  
Farseer of the Alaitoc Eldar

## IL'PORRUI "EMISSARY" CLASS ENVOY SHIP ..... 110 Points

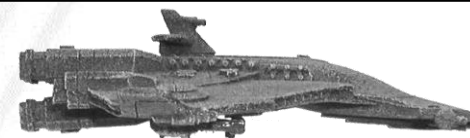
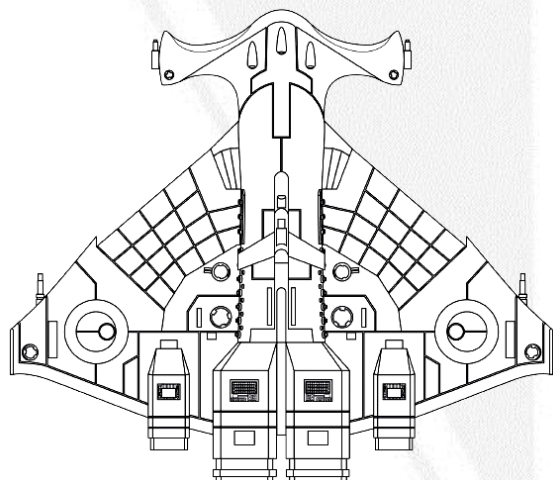

Unlike the other hull designs resulting from the Kor'or'vesh initiative, the Il'Porru "Emissary" cruiser is primarily intended as a diplomatic vessel. This provides it the necessary mix of firepower and maneuverability to make it a suitable conveyance to transport Por Caste dignitaries, Tau commanders and Ethereals in relative safety. By design, it is also capable of seeing off all but the most powerful adversaries of a similar class it may encounter.

As the first capital ship to be produced under the Kor'or'vesh, there are significant numbers of these vessels operating throughout Tau space in a variety of tasks. As befits its nature, it is the vessel with which the Tau perform long range exploration and "first contact" missions. It is often sent to rove far beyond Tau space on diplomatic assignments to the Tau's neighbors or in accompaniment of merchant transports, in this capacity it has most proven its worth to the Tau Empire.

While it may not be a front-line combat vessel, it is well suited to the fires of war, and during the latter stages of the Taros Campaign, a squadron of these vessels successfully boarded an Imperial battleship.

## IL'PORRUI DAL'YTH CONFIGURATION

TYPE /HITS	SPEED	TURNS	SHIELDS	ARMOR	TURRETS
Cruiser/4	20cm	90°	1	5+	2
ARMAMENT	RANGE	FIREPOWER/STRENGTH		FIRE ARC	
Port Railgun Battery	45cm	4		Left/ Front	
Starboard Railgun Battery	45cm	4		Right/ Front	
Port Gravitic Hook	-	Capacity: 1 Warden		-	
Starboard Gravitic Hook	-	Capacity: 1 Warden		-	
Prow Launch Bay	Barracudas: 25cm	2		N/A	

## IL'PORRUI BORK'AN CONFIGURATION

TYPE /HITS	SPEED	TURNS	SHIELDS	ARMOR	TURRETS
Cruiser/4	20cm	90°	1	5+	2
ARMAMENT		RANGE	FIREPOWER/STRENGTH		FIRE ARC
Port Railgun Battery		45cm	4		Left/ Front
Starboard Railgun Battery		45cm	4		Right/ Front
Port Gravitic Hook		-	Capacity: 1 Warden		-
Starboard Gravitic Hook		-	Capacity: 1 Warden		-
Prow Gravitic Launcher		Speed: 20-40cm	3		Front

## IL'PORRUI SA'CEA CONFIGURATION

TYPE /HITS	SPEED	TURNS	SHIELDS	ARMOR	TURRETS
Cruiser/4	20cm	90°	1	5+	2
ARMAMENT		RANGE	FIREPOWER/STRENGTH		FIRE ARC
Port Railgun Battery		45cm	3		Left/ Front
Starboard Railgun Battery		45cm	3		Right/ Front
Port Ion Cannon		30cm	1		Left/ Front
Starboard Ion Cannon		30cm	1		Right/ Front
Prow Gravitic Launcher		Speed: 20-40cm	3		Front

*Notes: Emissary class cruisers can be equipped with a deflector that raises its prow armor to 6 for +10 points. This is disabled whenever the vessel suffers a prow critical hit (repairable normally).*

*A large number of Il'Porru vessels were equipped with specialized grav hooks for supporting Kir'la "Warden" gunships so that it may have a form of escort on long-range emissary missions. These grav hooks are specially designed for Wardens and cannot be used to tow or count for any other kind of escort.*



## TAU SEPT WORLDS

The world or system from which a Tau hails from forms a large part of his or her identity. The culture of each of these many colonies or so-called sept worlds is subtly unique. This is due in part to the age of the colony – it may be one of the First Phase colonies established during the early stages of the Tau expansion into space, or it may be a much younger society. The relative proportions of the various castes differ from sept to sept too, and this may lend a certain outlook and character to the world's culture and the Tau born there.

**Vior'la:** A First-Phase colony, Vior'la orbits a binary star, and its name translates as 'hot-blooded.' A notorious Fire Caste world, its warriors are especially aggressive and skilled in the arts of death. The oldest and most respected of the Fire caste academies was founded here many centuries ago.

**T'olku:** Known for the sage counsel, debating and diplomatic skills of its Ethereal caste members, many of those Tau who have had successful dealings with alien species originate from this Second-Phase world.

**Dal'yth:** A very cosmopolitan First-Phase world where trade is valued as much as conquest, Tau from here welcome offworlders. As such, it has seen the most contact with alien species. Many Water-caste merchants and traders come from this sept.

**Bork'an:** A center of learning and academia, it has many universities and research facilities. A high percentage of the Fio, or Earth caste come from this First-Phase world.

**Sa'cea:** One of the hottest and most densely populated Tau worlds, this First-Phase sept has a greater proportion of Fire Warriors than almost any other and is highly militarized. Those hailing from Sa'cea are regarded as particularly disciplined and honorable warriors.

**Vash'ya:** Known as the "world between spheres," members of the Kor caste have a long tradition on this Second-Phase sept, providing a majority of the pilots and ship crews for the Tau's early expansion into the greater galaxy.

**Ksi'm'yen:** One of the first Third-Phase septs, it has yet to emerge as a distinct society. Conquered largely by stealth, a combination of Second-Phase fleets and hunter cadres wrested this from the Imperium when it was stripped of its defenders due to pressing needs elsewhere.

## KIR'SHASHVRE "CASTELLAN" CLASS ESCORT ..... 50 Points

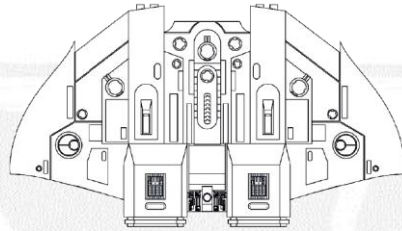

TYPE /HITS	SPEED	TURNS	SHIELDS	ARMOR	TURRETS
Escort/1	25cm	90°	1	5+	2
ARMANENT		RANGE	FIREPOWER/STRENGTH		FIRE ARC
Prow Railgun Battery		45cm	2		Left/ Front/ Right
Prow Gravitic Launcher		Speed: 20-40cm	2		Front

*Notes: This vessel may squadron with any other Tau escorts normally except Orcas (max. six per squadron), but those in a squadron with Wardens may not also be with any other escort type.*

Operations by the Kir'Qath "Defender" starship revealed that while it was a capable escort, continuing shortcomings in its engineering plant required a new vessel design that could make much deeper and longer dives as well as a larger number of dives before requiring to recharge its primary drives. Like the other vessels designed during the Kor'or'vesh initiative, its unique hull design allows for considerably longer-range operations compared to its predecessor. Deployed in the role of traditional escort vessel, it has proven directly comparable to commonly encountered Imperial designs. Around Taros the Tau fleet deployed Castellans in large numbers in support of their larger vessels with great success.

## IL'EMAAR "COURIER" CLASS MERCHANT TRANSPORT ..... Special

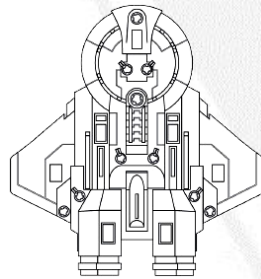

TYPE /HITS	SPEED	TURNS	SHIELDS	ARMOR	TURRETS
Escort/1	20cm	45°	1	5+	1
ARMANENT		RANGE	FIREPOWER/STRENGTH		FIRE ARC
Prow Railgun Battery		30cm	1		Left/ Front/ Right

*Notes: Il'Emaar merchant transports support the Kor'vattra in a variety of missions but are usually crewed by more junior members of the Kor-caste. They have a -1 modifier when determining base leadership. These vessels are reserved for scenarios that require transports, for which they have the value of a full transport or two assault points.*

Their long and protracted war with the Or'es'la proved early on that the numerous but relatively fragile merchantmen that were the life-blood of the rapidly expanding Tau Empire were woefully inadequate. Continuing raids decimated the fleets of these small ships, requiring a whole and much larger class of heavily armed transport in the form of the Il'Fannor. As time progressed, smaller transport classes almost disappeared entirely, though many various types still found use among and between the major Septs of Tau space. However, as the Kor'or'vesh began operating throughout Tau space and beyond, a new kind of fast transport was required that could make long, deep dives in support of the fleet and quickly replenish forward-deployed flotillas. While this vessel was originally designed to support the Kor'or'vesh, the obvious utility of these vessels was expanded to the Greater Empire, and now these easily produced starships are common sights throughout Tau space and beyond.

### Using Merchant Transports in a Tau Fleet for scenarios requiring transports

Due to the nature of the Tau Kor'vattra, there are a large proportion of heavy transports in the fleet. In any scenario requiring transports, up to half the transports allowed in the fleet may be replaced with Il'fannor "Merchant" heavy transports if desired, each for their normal point cost. These ships are represented by the variant equipped with gravitic hooks (not ion cannons!). When used, their accompanying Orcas or other towed escorts must count toward the fleet escorting the transports, in addition to the point value of the Merchant starships themselves. They count as two transports in all respects and have four planetary assault points (these values are halved if crippled).

## PLANETARY DEFENSES

These Planetary Defense profiles vary slightly from those available in Armada and are perfectly suited for the models produced by ForgeWorld. They can be used in any scenario requiring Planetary Defenses.

# TAU KOR CASTE ORBITAL CITY ..... 150 Points

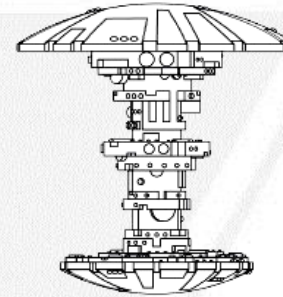
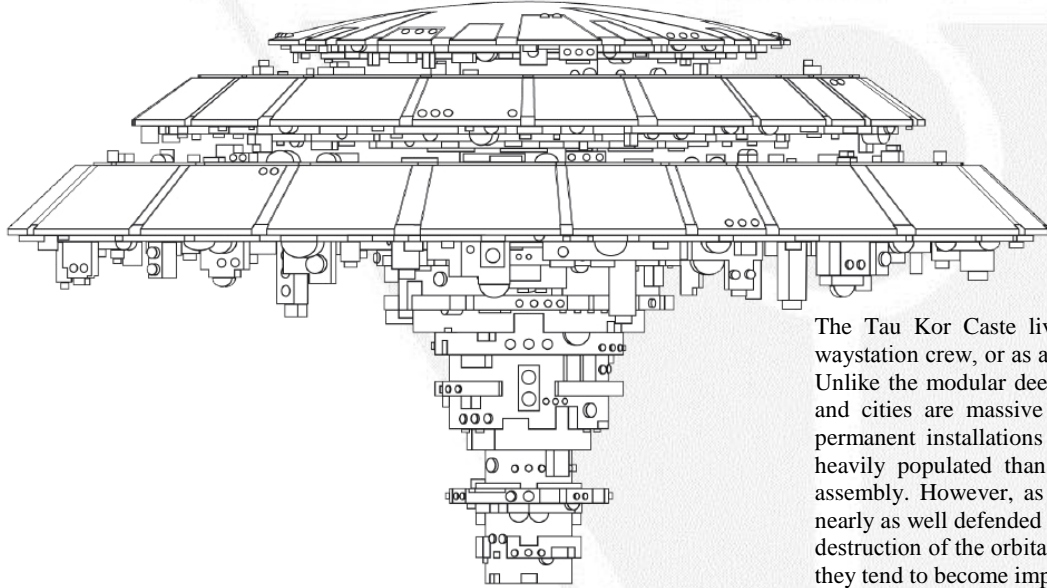

Orbital City and smaller Security Orbital

The Tau Kor Caste live much of their lives in zero-gravity, either as spacecraft or waystation crew, or as a resident in one of many of the Caste's own large orbital habitats. Unlike the modular deep-space way-stations used throughout Tau space, orbital habitats and cities are massive constructs usually assembled in place as permanent or semi-permanent installations in high orbit. By their very nature they are sturdier and more heavily populated than the modular way-stations designed for rapid deployment and assembly. However, as they are primarily designed for habitation, they tend to be not nearly as well defended as other orbital constructs, as demonstrated by the relatively quick destruction of the orbital facilities of Viss'el during the Damocles Gulf Crusade. As such, they tend to become important rallying points when defending against an invasion force.

TYPE /HITS	SPEED	TURNS	SHIELDS	ARMOR	TURRETS
Defense/10	0cm	0°	3	5+	4
ARMAMENT		RANGE	FIREPOWER/STRENGTH		FIRE ARC
Railgun Battery		45cm	12		All Around
Launch Bays		Mantas: 20cm Barracudas: 25cm	4		N/A
Gravitic Hook		-	2 Orcas/Wardens		-

*Notes: Like many deep-space way-stations, Tau Orbital Cities and Security Orbitals are equipped with comprehensive sensor and communication suites with a high degree of automation. They are equipped with the same Tracking System as "Messenger" starships. Orcas assigned to guard an Orbital City have a base leadership of 7 and cannot squadron with other escorts.*

# TAU SECURITY ORBITAL ..... 50 Points

TYPE /HITS	SPEED	TURNS	SHIELDS	ARMOR	TURRETS
Defense/4	0cm	0°	1	5+	4
ARMAMENT		RANGE	FIREPOWER/STRENGTH		FIRE ARC
Railgun Battery		45cm	4		All Around
Ion Cannon		30cm	1		All Around

While most Second and Third-Phase Septs in the Tau Empire rely on quickly deployed modular way stations and Orbitals for their defensive and operational requirements, most primary Septs and a small number of firmly established secondary systems have a quantity of permanently situated orbital defenses. These security orbitals tend to be somewhat stouter than other single-point defenses without the complexity or size of full stations.

**ALLIES, SUBJECTS & MERCENARIES**

*As the Tau more fully integrate themselves with the Demiurg, they make regular contact with vessels rarely encountered by other races. Likewise, their ongoing conflict with the Orks made them party to a supremely rare sight- the power and magnificence of an assembled Demiurg war host.*

**DEMIURG ‘CITADEL’ COMMERCE VESSEL ..... 185 Points**

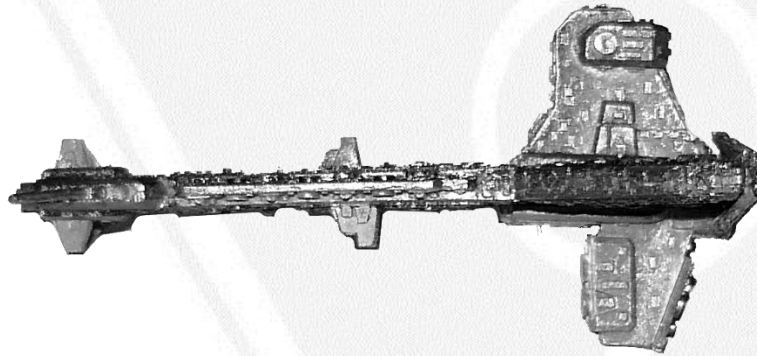

Hidden among the more closely-guarded systems frequented by the Demiurg are vessels specialized for mining and resource harvesting. These vessels outwardly resemble Bastion vessels in all respects but vary in critical details. The volume in Bastion vessels dedicated to attack craft and broadside lances is entirely turned over to specialized resource harvesting equipment. Outwardly they resemble the more familiar but still rare Bastion commerce vessels in all respects, and only through their interaction with the Tau did some Rogue Traders become aware there was a distinction between ship types.

TYPE /HITS	SPEED	TURNS	SHIELDS	ARMOR	TURRETS
Cruiser/6	20cm	45°	2	5+/6+ Prow	3
ARMAMENT		RANGE	FIREPOWER/STRENGTH		FIRE ARC
Port Weapons Battery		30cm	6		Left
Starboard Weapons Battery		30cm	6		Right
Prow Weapons Battery		45cm	8		Front
Prow Cutting Beam		15cm	Special (max 8)		Front
Dorsal Torpedoes		Speed: 30cm	4		All Around

**Demiurg Cutting Beam**

This weapon is a short ranged but devastating ionization beam. In addition to the rules described for this weapon on p.109 of Armada, any Demiurg vessel may extend the range of its cutting beam to 30cm by expending two collected blast markers per weapon strength instead of one, rounding down. For example, a Demiurg Bastion that gathers up four blast markers in the course of its immediately previous movement may in the shooting phase fire a str-5, range-15cm cutting beam or a str-2, range-30cm cutting beam.

*Notes: Demiurg Citadel class ships are heavily automated and count their Ld value as 9 at the start of the battle. The Citadel's Ld will drop by -1 for each point of damage it suffers, but its Ld value will not drop any further than 5. Bridge smashed critical hits will not inflict additional Leadership loss on a Demiurg ship, but instead cause an extra point of damage (and possible attendant Ld loss) on the vessel.*

*A Citadel class vessel is worth 185 Victory points normally but in a pure Demiurg fleet or one fighting against Orks it is worth 200 Victory points instead to reflect its extra determination. This does not affect its starting point cost.*

*Demiurg 'Citadel' class vessels cannot employ Come to New Heading special orders.*

**Using Citadel Commerce Vessels**

*Citadel Commerce Vessels outwardly resemble Bastion Commerce vessels in all respects, and the same model may be used to represent either ship class. To represent its complex resource-gathering and harvesting systems, the model is mounted on a large base, which due to the unique nature of Demiurg shields is not nearly the handicap it would be for other races! It can be used as allies in the same manner as Bastion Commerce Vessels in any fleet that can take Bastions. This allows Demiurg vessels to be used in a pure fleet or be taken as a ship choice in scenarios limited by the amount of points that may be taken.*

*“You misunderstand, this is Tau space, despite what the Gue’la may claim, and you are welcomed to it as friend. We too have suffered difficulty with the Or’es’la, since it seems they wish no unity. We would be honoured to have you fight alongside us against this common enemy. You will find it to the benefit of both our peoples. You will find it, I have no doubt, to be for the Greater Good.”*

*-Por’O Dal’yth V’Rok  
greeted the Thurm Brotherhood  
during first contact with the Demiurg*

## NICASSAR CARAVAN ..... 200 Points

TYPE /HITS	SPEED	TURNS	SHIELDS	ARMOR	TURRETS
Defense/8	10cm	Special	4	5+	6
ARMAMENT		RANGE	FIREPOWER/STRENGTH		FIRE ARC
Railgun Battery		30cm	10		All Around
Gravitic Hook		-	4 Dhows (see notes)		-

*Notes: Their point cost and profile above reflects a slightly modified Nicassar Rig and four Dhows, as described on pp.106-107 of Armada. Nicassar Caravans are ponderously slow, but like their individual Dhows, they are surprisingly maneuverable. A Nicassar Caravan moves 10cm in any direction during the movement phase, no more, no less. It is not slowed down by blast markers, celestial phenomena or being crippled, and it cannot take Burn Retros, Come To New Heading or All Ahead Full Special Orders. Nicassar Caravans have +1 Leadership (max. 10).*

### Using Nicassar Caravans

As opposed to a Rig and its separate Dhows described on pp.106-107 of Armada, a Nicassar Caravan in motion has its Rig and Dhows as a single entity that does not separate throughout the course of the battle and is treated as a single vessel in all respects. It can be crippled normally, but it does not take critical damage in the normal sense. If the Caravan takes critical damage, apply an additional 1Hp damage instead. When a Caravan is reduced to zero hits, it and its Dhows all count as destroyed. Remove it from play and replace it with four blast markers centered around the point where it was destroyed.

Though they have very little combat utility, Nicassar have powerful minds and rely on their telekinetic talents in particular to make up for their own limited mobility. Their extended families are semi-nomadic and are driven by insatiable curiosity. Their spacefaring skills are exemplary, and it is in this manner they best serve the Greater Good. Trading caravans are the large networks of conjoined Dhows which the Nicassar employ when travelling over long distances at their natural leisurely pace, sometimes over the course of centuries.

As they are most content when travelling and can survive for long periods in virtual hibernation, they are uniquely suited for their service to the Tau, exploring systems on the fringes of the Tau Empire. Occasionally caravans accompany Tau fleets to war, and if attacked the Dhows will attempt to move the community to safety, though it is not unknown for them to detach and fight vigorously in defense of their community and the Tau vessels supporting them.

## NICASSAR RIG ..... 40 Points

TYPE /HITS	SPEED	TURNS	SHIELDS	ARMOR	TURRETS
Defense/4	0cm	0°	1	5+	6
ARMAMENT		RANGE	FIREPOWER/STRENGTH		FIRE ARC
Gravitic Hook		-	4 Dhows		-

*Notes: For every Nicassar Rig in the fleet, four Dhows must be purchased as described on pp. 106-107 of Armada. Their gravitic hooks count toward the number of Dhows in the fleet and cannot be used on any other escort type.*

### Using Nicassar Rigs

A Nicassar Rig and its four Dhows remain separate throughout the course of a battle, and the rig itself is stationary in the same manner of any other planetary defense. However, it is not limited as to where it is placed on the table unlike other planetary defenses and does not need to be placed within 15cm of celestial phenomena. A Caravan and a Rig with its four Dhows are essentially identical, despite the different profiles listed above. In the course of a campaign, a player may substitute one for the other for every Rig or Caravan on the fleet list before the start of a battle simply by deciding whether or not the Rig is to move or remain stationary. Once the decision is made, it cannot be changed until the start of the following battle.

Upon encountering something of interest in wilderness space, a Nicassar Caravan will detach a number of its Dhows to investigate, though it is immobile while its Dhows are maneuvering separately in this manner. While Caravans will always attempt to retreat in the face of hostility, it is not unknown in desperate situations for a Rig's Dhows to remain separate and actively defend it against a particular threat.



# KOR'OR'VESH VESSELS IN THE KOR'VATTRA FLEET LIST

*Kor'or'vesh vessels can be deployed in a particularly important Commerce and Exploration fleet as a mixed flotilla of vessels integrated in the current Tau list in Armada, with a number of restrictions due to their great expense and rarity.*

## TAU KOR'OR'VESH: COMMERCE PROTECTION FLEET

*This fleet list is identical to that on p. 112 of Armada, with the following changes and/or additions:*

### FLEET COMMANDER

*Your fleet must include a commander if it is greater than 750 points. If it is greater than 750 points, the commander may be a Kor'el or a Kor'O. If the fleet includes a Custodian, a Kor'O must lead it.*

Tau Kor'el (Ld 8) . . . . . 50 points  
 Tau Kor'O (Ld 9) . . . . . 80 points

The commander has one re-roll included in his points cost. If you wish, the commander's ship may carry a member of the Ethereal caste and therefore purchase additional re-rolls at the cost shown.

Aun'el (one extra re-roll) . . . . . +25 points  
 Aun'O (two extra re-rolls) . . . . . +75 points

### CAPITAL SHIPS

#### Battleships

*Your fleet may include any number of Explorer battleships. Your fleet may include up to one Custodian per FULL 750 points of Tau vessels. Allied vessels don't count toward this total. For example, a fleet that has at least 750 points of Tau vessels in it may include a single Custodian. Fleets of at least 1,500 points may include two Custodians.*

Custodian class battleship . . . . . 330 points  
 Explorer class starship . . . . . 230 points



### Cruisers

*Your fleet may include any number of Merchant, Emissary or Protector class starships. It may also include up to one Hero class starship for every other type of capital ship in the fleet.*

Protector class starship . . . . . 185 points  
 Hero class starship . . . . . 180 points  
 Emissary class starship . . . . . 110 points  
 Merchant class starship . . . . . 95 points

### ESCORTS

*Your fleet may include up to one Messenger class starship per 500 points.*

Messenger class starship . . . . . 50 points

*Your fleet may include any number of Defender and/or Castellan class starships.*

Castellan class starship . . . . . 50 points  
 Defender class starship . . . . . 45 points

*You may not have more Orcas and Wardens than the gravitic hook capacity of the fleet. Much of the cost of these vessels is included in that of the parent ship.*

Warden class gunship . . . . . 30 points  
 Orca class gunship . . . . . 25 points

### ALLIES, SUBJECTS & MERCENARIES

The rules described on pp.107-112 of Armada remain unchanged except as described here.

#### Demiurg Vessels

*There cannot be more Stronghold than Bastion vessels in the fleet.*

Stronghold Commerce Vessel . . . . . 350 points  
 Bastion Commerce Vessel . . . . . 255 points  
 Citadel Commerce Vessel . . . . . 185 points

#### Kroot Vessels – (0-2)

*Warspheres do not count against cruiser limits in a Kor'vattra Fleet.*

Kroot Warsphere . . . . . 145 points

### Using Kroot Warspheres

The Kroot approach spacefaring with an innate sense bereft of the technological advances so keenly sought by other races. When the Damocles Crusade revealed shortcomings in the Warsphere compared to Imperial starships, the Kroot adapted simply by constructing larger Warspheres.

In any fleet list, a Kroot Warsphere may subtract up to -4HP or add up to +6HP from its regular profile, for 20 points added or subtracted per 2HP. For every 2HP, it adds or subtracts +2 firepower to its weapons battery. Warspheres 10HP or greater may also add +1 shield and/or turret strength for +10 points each (no more than one each). A Kroot Warsphere 10HP or greater can extend the range of its weapons battery by +15cm for +25 points.

During planetary assaults, Kroot Warspheres cannot return to flight during a battle once they have landed. However, they are not destroyed and only count as disengaged for purposes of victory points.

### Nicassar Vessels

*No more Dhows may be taken than the grav hook capacity of the fleet. Grav hooks on a Custodian battleship or Emissary starship cannot count toward this total.*

Nicassar Caravan . . . . . 200 points  
 Nicassar Rig . . . . . 40 points (+ 4 Dhows)  
 Nicassar Dhow . . . . . 45 points

### Rogue Traders

*Up to one Rogue Trader cruiser and its attendant escorts may accompany the fleet for every 750 points of Tau ships in the fleet. Additionally, a single squadron of up to six Xenos escorts can be taken as per the Rogue Trader rules and fleet list.*

Rogue Trader Cruiser . . . . . 185 points  
 Endeavor Light Cruiser . . . . . 110 points  
 Xenos vessel . . . . . 50 points  
 Recommissioned escort . . . . . 30 points  
 Iconoclast destroyer . . . . . 30 points  
 Rogue Trader cargo vessel . . . . . 20 points

# THE DEMIURG AND KROOT XENOS FLEET LIST

## WAR HOST OF THE DEMIURG

The Demiurg will typically shy away from combat, though occasionally they will respond to threats with surprising ferocity. The Demiurg have plied the stellar void millennia before encountering the Tau, and on exceedingly rare occasion will muster their ships for war for reasons entirely unrelated to their relationship to the Tau.

## AFFILIATION OF BROTHERHOODS

Demiurg fleets are composed of a loosely-defined but tightly knit affiliation of "Brotherhoods" that rely on an exceedingly high level of automation and are not organized in the manner of typical fleet organizations. Because of this, Demiurg fleets have no Fleet Commander in the conventional sense, which affects their fleet in the following ways:

### Re-rolls

A Demiurg fleet may purchase re-rolls, but they are purchased by the fleet as a whole, rather than being considered Fleet Commander rerolls. The fleet gets one re-roll and can purchase extra re-rolls at the cost shown. These re-rolls can only be used for Demiurg vessels and not with other starships they may take as allies in their war host.

One extra re-roll . . . . . 25 points  
Two extra re-rolls . . . . . 75 points

### Determination

Demiurg vessels used against this fleet list do not attempt to disengage unless they have 2Hp or less remaining. Though their point cost remains unchanged, Strongholds are worth 400 points, Bastions are worth 300 points and Citadels are worth 200 points when determining Victory Points.

## CAPITAL SHIPS

### Battleships

Your fleet may include one battleship for every two cruiser-class vessels in the fleet.

Stronghold Commerce Vessel . . . . . 350 points

### Cruisers

Your fleet may include no more than twelve cruisers. Demiurg Commerce Vessels must outnumber all non-Demiurg cruisers combined.

Bastion Commerce Vessel . . . . . 255 points  
Citadel Commerce Vessel . . . . . 185 points  
Protector class cruiser . . . . . 185 points  
Rogue Trader Cruiser . . . . . 185 points  
Hero class starship . . . . . 180 points  
Endeavor light cruiser . . . . . 110 points  
Emissary class starship . . . . . 110 points  
Merchant class starship . . . . . 95 points

### Kroot Vessels – (0-3)

The Demiurg have a unique, little-understood relationship with the Kroot pre-dating that with the Tau, and it is not uncommon for their ships to be encountered together.

The fleet may have one Kroot Warsphere in the fleet for every 750 points in the fleet or portion thereof. These do not count against the number of cruisers in the fleet. (See note on p.15 concerning Warspheres).

Kroot Warsphere . . . . . 145 points

### ESCORTS

The Demiurg do not make use of escorts in the same manner of other fleets. However, they will contract or otherwise arrange the use of escort squadrons as the need arises.

For every three Demiurg capital ships in the fleet, it may include one squadron of up to six Tau or Rogue Trader escorts. Nicassar Dhows, Tau Wardens or Orcas can be taken for every starship in the fleet equipped with grav hooks. Tau, Nicassar and Rogue Trader escorts may not be mixed in the same squadrons.

### Tau Escorts

Castellan class starship . . . . . 50 points  
Defender class starship . . . . . 45 points  
Nicassar Dhow . . . . . 45 points  
Warden class gunship . . . . . 30 points  
Orca class gunship . . . . . 25 points

### Rogue Trader Escorts

Xenos vessel . . . . . 50 points  
Recommissioned escort . . . . . 30 points  
Iconoclast destroyer . . . . . 30 points  
Rogue Trader cargo vessel . . . . . 20 points

## ORDNANCE & UPGRADES

Demiurg ships utilize highly automated versions of torpedoes, fighters, bombers and assault boats. They do not have access to boarding torpedoes but may use torpedo bombers for +10 points per launch bay.

### Leadership and Attack Rating

The Demiurg fleet has an Attack or Initiative rating of 2. Vessels allied with the Demiurg rely on the basic leadership applicable to their fleets. They cannot use Demiurg fleet re-rolls, but if available they may purchase special characters with any re-rolls they come with to lead their ships.

### Campaigns

In campaigns, Demiurg and vessels on this fleet list allied with them may gain leadership, crew skills and refits in the same manner as Imperial vessels (max Ld-10).

